

Parrot UNIKA for Jaguar cars

Parrot UNIKA is a universal interface that allows you to control the Parrot MKi9000/MKi9100/MKi9200 directly with the OEM steering wheel commands. Parrot UNIKA can work with car protocols such as CAN, KBUS or resistive systems.



Before installing the Unika, make sure you have the latest software update on your Parrot MKi.

If you have a Parrot MKi9100, make sure you also have the 3.1 display version. To do so, select **Settings > Advanced settings > Information**.

Installation

Compatibility
Car models Jaguar X-Type: > 2004
 Jaguar S-Type: > 2004



Parrot
reference For Parrot MKi9000 / MKi9100 / MKi9200
 Parrot UNIKA : **PI090020AA**



Installation of the Parrot MKi We recommend you to install the Parrot MKi before installing the UNIKA. Make sure the installation is correctly performed by checking if the «Good bye» message is displayed when you turn off the ignition.
► *Refer to the documentation of your Parrot MKi for more information.*

Selecting the protocol Use the DIP switches located on one side of the UNIKA to select the protocol (resistive or CAN Bus / KBus) on which the vehicle is based.

Warning: *Make sure the UNIKA is not powered before selecting the protocol.*

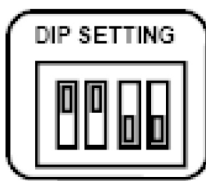

Set the DIP this way if you have an OEM radio.

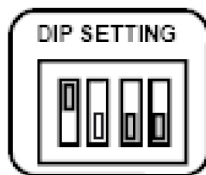

Set the DIP this way if you don't have an OEM radio.

Power supply The power supply for the UNIKA interface is taken from the power cable of the Parrot MKi. It is important to follow the color code of the power cable wires: the red wire of the kit's cable corresponds to the permanent 12V supply; the orange wire corresponds to the ignition 12V ; the black wire is for ground ; the yellow wire corresponds to the Parrot mute output.

Warning : *Connect the ignition to the Parrot car kit if the vehicle is based on a resistive or a K-Bus protocol. Don't connect the ignition if the vehicle is based on a CAN protocol.*

On some vehicles, the 12V power wires may be reversed, in which case you must reverse the red and orange wires of the hands-free kit's power supply. This can easily be done by reversing the two fuse holders on the kit's power cable.

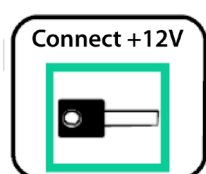

12V ignition is not provided.
Get the 12 V ignition from the car.

Resistive protocol

The wires corresponding to the resistive protocol must be connected correctly to your car stereo's. It is important to follow the wiring diagram for your vehicle.

Checking the wiring Once your UNIKA interface has been fitted, the LED should light up green and should turn amber while pressing a button on your steering wheel. If the LED does not light up, check the power supply connections. If the LED is red or blinks red, check the connections.

Warning : Once the installation is complete, turn the ignition off until the UNIKA LED switches off.

Reset procedure In case of problem or if you have installed the UNIKA interface in another car, reset the UNIKA by holding down the Reset button until the LED turns off (if the vehicle is based on a CAN Bus / KBus protocol) or blinks red (resistive protocol). You can then release the reset button.

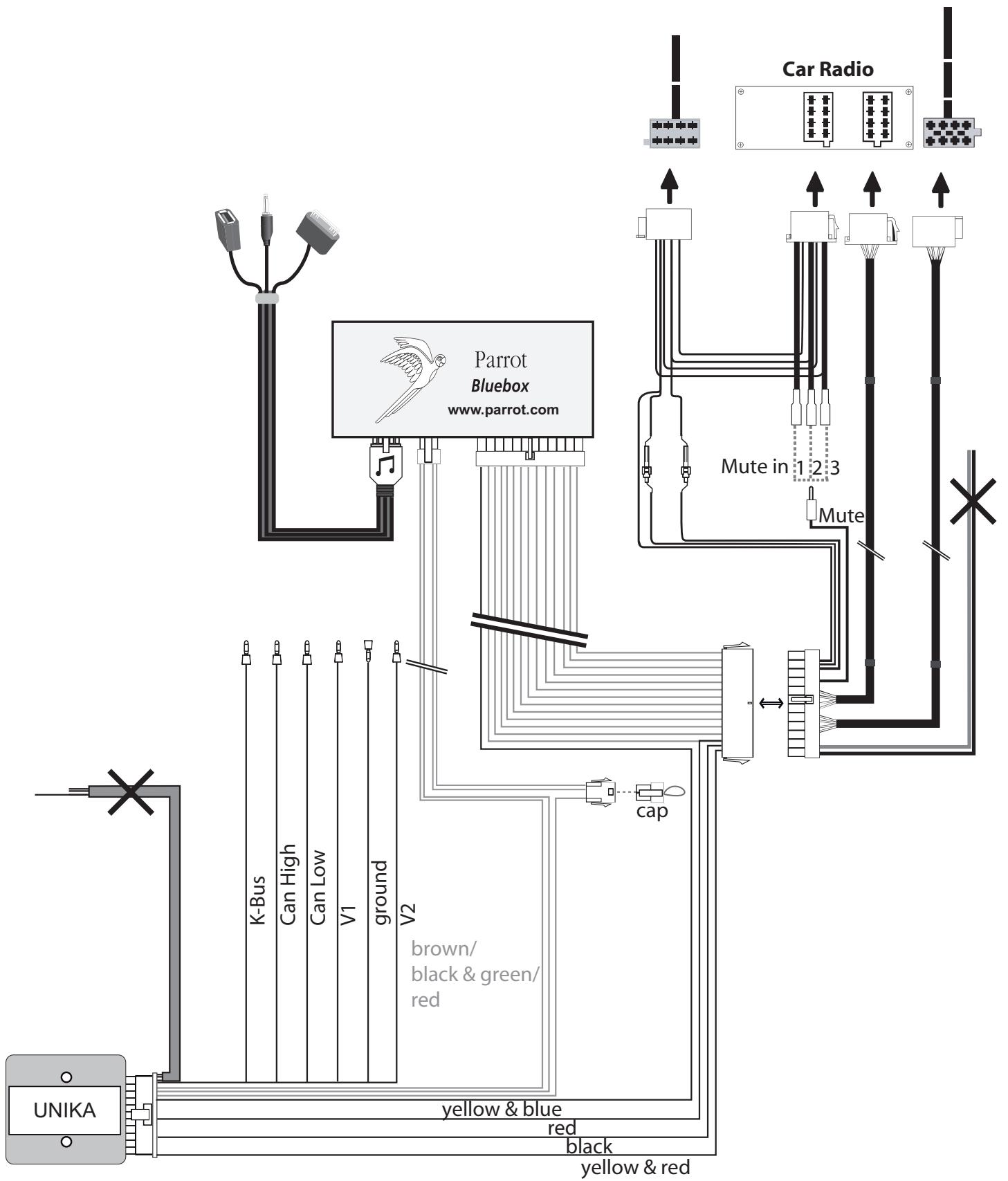

Parrot MKi9000

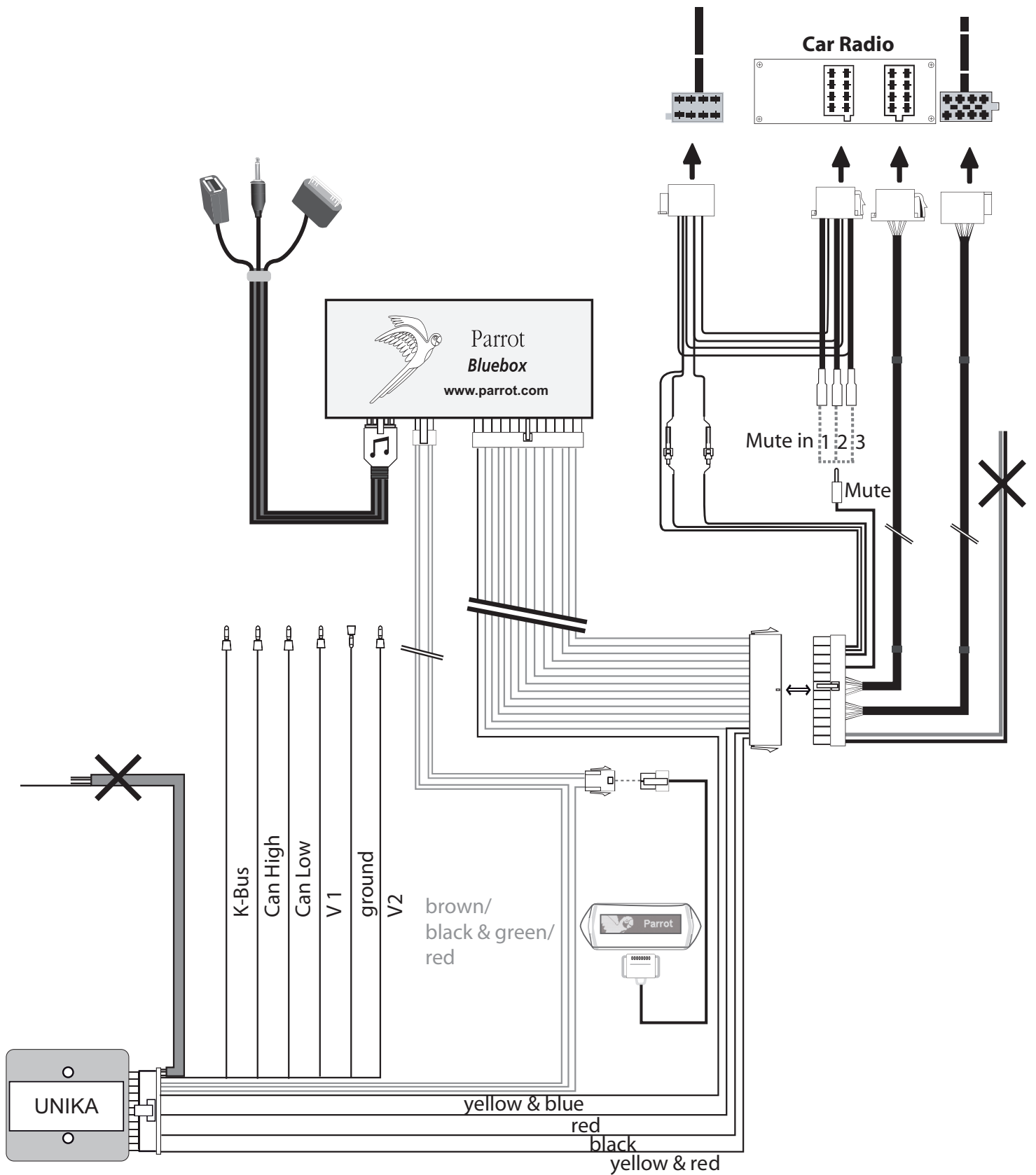

Parrot MKi9100

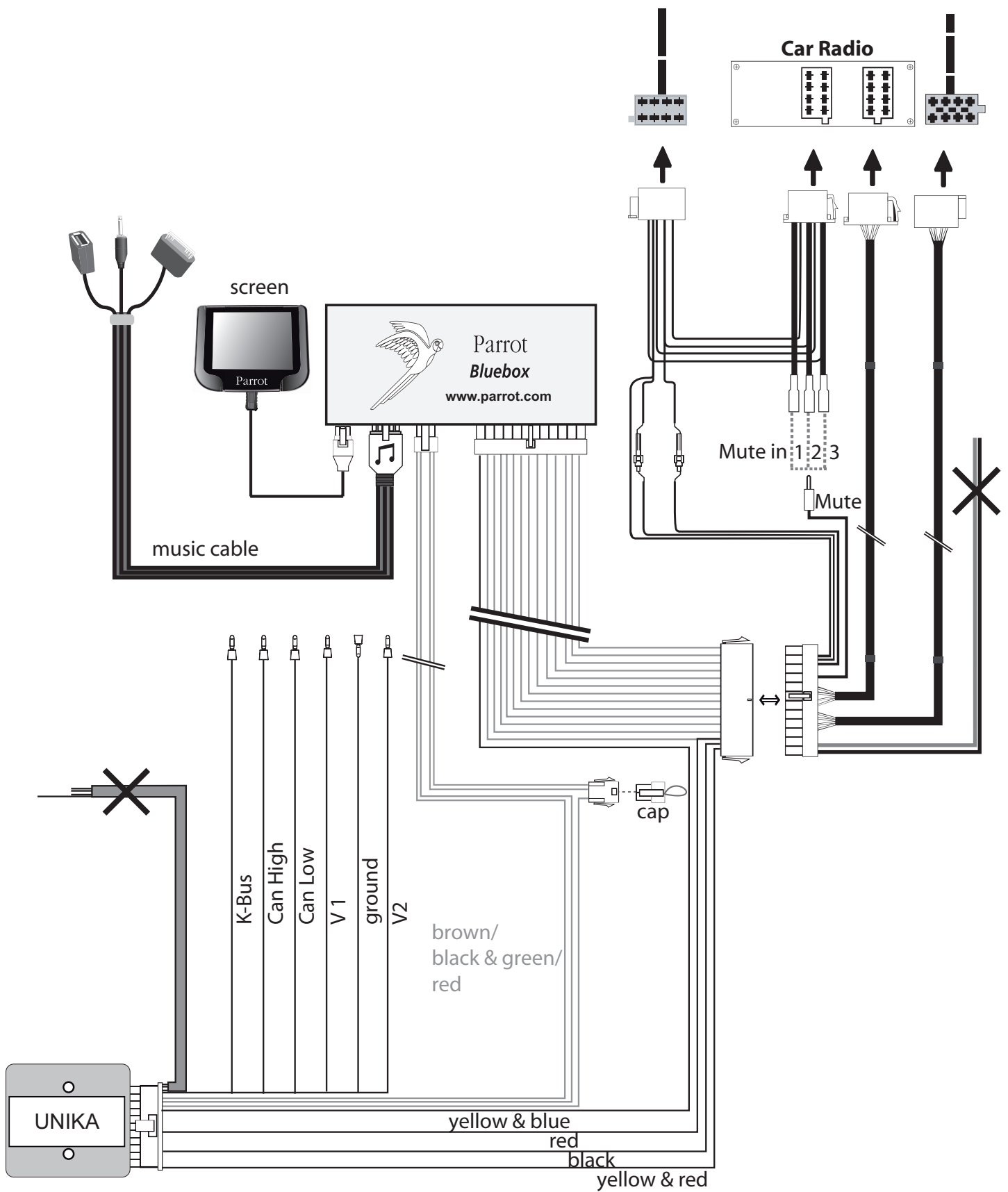

Parrot MKi9200

COM Configuration Jaguar

The wires corresponding to the Jaguar protocol configuration must be connected correctly to your car stereo's information. It is important to follow the wiring diagram for your vehicle. We would advise our customers to have the interface fitted by a professional.

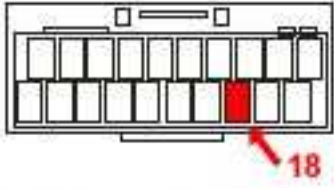
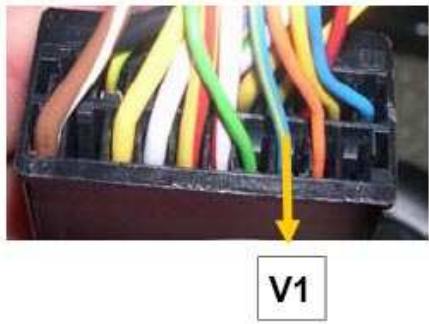
N°	Color	Function	Connectors
18	Pink	V1	
-	Pink & Black	V2	

Connect the pink wire corresponding to V1 to pin 18.

Connect the pink & black wire corresponding to V2 to the black wire of the Multicomm harness.

If your car stereo supports mute signal management, then your actions on the steering wheel commands while using a Parrot MKi will not be taken into account by the car stereo.

To find out the mute position of your car stereo, refer to the documentation of your device or contact the car manufacturer.



1- Programming Parrot UNIKA for your car

The wires corresponding to the resistive protocol must be connected correctly to your car stereo's. It is important to follow the wiring diagram for your vehicle.

Defining the mode

If your vehicle is based on a resistive protocol, you have to define the mode manually:

1. Turn the ignition on.
> The LED blinks red once.
2. Press the buttons on the steering wheel in the following order:



> Each time you press a button, the LED blinks in red.

Reset procedure

In case of problem or if you have installed the UNIKA interface in another car, reset the UNIKA by holding down the Reset button until the LED turns off (if the vehicle is based on a CAN Bus / KBus protocol) or blinks red (resistive protocol). You can then release the reset button.

Specific case If you do not have 7 buttons on your steering wheel, hold down the last button for two seconds until the LED turns green.

Warning : *Once the installation is complete, turn the ignition off until the UNIKA LED switches off.*

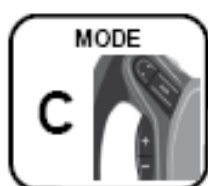

Your system runs on C mode.

Resistive protocol

The wires corresponding to the resistive protocol must be connected correctly to your car stereo's. It is important to follow the wiring diagram for your vehicle.

Checking the wiring Once your UNIKA interface has been fitted, the LED should light up green and should turn amber while pressing a button on your steering wheel. If the LED does not light up, check the power supply connections. If the LED is red or blinks red, check the connections.

Warning : Once the installation is complete, turn the ignition off until the UNIKA LED switches off.

Reset procedure In case of problem or if you have installed the UNIKA interface in another car, reset the UNIKA by holding down the Reset button until the LED turns off (if the vehicle is based on a CAN Bus / KBus protocol) or blinks red (resistive protocol). You can then release the reset button.

2 - Features

Depending on the steering wheel control in your vehicle, the UNIKA interface will enable you to take full advantage of the telephone and music functions in 4 different modes: Mode A (4 buttons), Mode B (5 buttons), Mode C (6 buttons) and Mode D (7 buttons). The selection of this mode depends on the protocol of the vehicle.

Note : Pictograms on the buttons depend on the model of the vehicles.



Short press



2 short presses



Long press



Volume









Seek



Source



Pick up - Hang up

Warning : *The mode you will use depends on the number of available buttons and not on the pictograms. For instance, if you have the      buttons, you will use the UNIKA in mode B : consider the  button is replaced by the  button.*

Mode C



Enter the menu / Entrer dans le menu / Entrar en el menú / Öffnen eines Menüs / Accedere al menu / Het hoofdmenu openen



Navigate through the menus / Naviguer dans le menu / Navegar por los menús / Navigation in den Menüs / Consente di utilizzare i menu / In de menu's navigeren



Confirm menu choice / Confirmer / Validar la selección / Bestätigung einer Auswahl / Confermare la selezione / De selectie valideren



Back menu / Menu précédent / Menú anterior / Rückkehr zum vorhergehenden Menü / Consente di tornare al menu precedente / Vorige menu



Adjust the volume / Modifier le volume / Ajustar el volumen / Einstellung der Lautstärke / Modificare il volume / De geluidssterkte regelen



Answer an incoming call / Répondre à un appel / Descolgar una llamada / Entgegennehmen eines eingehenden Anrufs / Rispondere a una chiamata / Een inkomend gesprek opnemen



Refuse an incoming call / Refuser un appel / Colgar una llamada / Beenden eines eingehenden Anrufs / Rifiutare una chiamata / en inkomend gesprek weigeren



Hang up / Raccrocher / Rechazar / Ablehnen / Riagganciare / Ophangen



Discreet mode / Mode discret / Modo discreto / Diskreter Modus / Modalità privata / Privacy modus



Exit discreet mode / Sortir du mode discret / Salir del modo discreto / Beenden des Diskreter Modus / Disattivare la modalità privata / De discrete modus opheffen



Start the voice recognition feature / Lancer la reconnaissance vocale / Iniciar el modo de reconocimiento de voz / Aktivieren der Spracherkennung / Attivare la funzione di ricon. vocale / De modus Spraakherkenning sluiten



Redial function / Fonction Bis / Función de rellamada / Wiederholung des letzten Anrufs / Funzione Bis / Bis functie



Mute Mic / Couper le microphone / Desactivar el micrófono / Das Mikrophon deaktivieren / Disattivare il microfono / De microfoon in- of uitschakelen



Next - previous track / Morceau suivant - précédent / Pista siguiente - precedente / Vorhergehende - nächsten Stück / Brano precedente - successivo



Play - Pause / Parar - reproducir música / Anhalten - Fortsetzen der Wiedergabe / Interrompere - riprendere la lettura /