

## Parrot MULTICOMM For Alfa Romeo steering wheel

**Parrot MULTICOMM** is a unit able to control Parrot H/F kits with the car's steering wheel commands working with ANALOG STEERING WHEEL COMMANDS with OEM headunit installed.

This unit is available in two versions, one working with the CK3000 Evolution, another for the CK3100.



### Compatibilty car models :

**Alfa Romeo 146**  
**Alfa Romeo 147 : 2004 - 2007**  
**Alfa Romeo 156 : 2004 - 2007**  
**Alfa Romeo GT : 2004 - 2007**  
**Alfa Romeo GTV**



### Parrot Reference :

If you are interested, contact our sales department: [sales@parrot.fr](mailto:sales@parrot.fr)

#### For Parrot CK3000 EVOLUTION

- Parrot MULTICOMM : **PI090003AA**

#### For Parrot CK3100 LCD

- Parrot MULTICOMM : **PI090004AA**



### Features :

Depending on your vehicle's steering wheel controls, there are several possibilities for using a hands-free kit with the steering wheel controls:

- **Mode 1:** the steering wheel does not feature any phone button, but only volume adjustment controls ("Volume (+)" and "Volume (-)" buttons)
- **Mode 2:** the steering wheel features a single "Phone" button
- **Mode 3:** the steering wheel features an "Answer" button and a "Hang up" button

With these Alfa Romeo cars, you can only use **Mode 1**.

## Mode 1: Using with the volume adjustment buttons

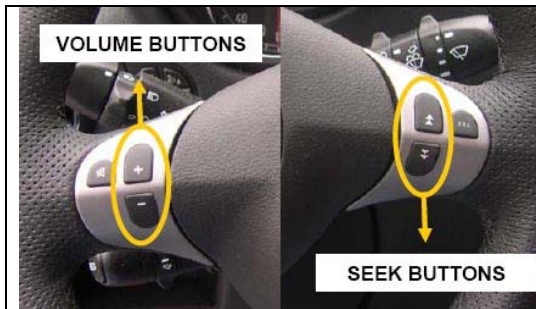

Depending on the steering wheel controls in your vehicle, the MULTICOMM interface will enable you to take full advantage of the features available on your hands-free kit:

•Answer an incoming call:	Press the "Volume (+)" button.
•End a call:	Press the "Volume (-)" button.
•Refuse an incoming call:	Press the "Volume (-)" button.
•Start the voice recognition feature:	Quickly press the "Volume (+)" button, then press the "Volume (-)" button.
•Redial the last number:	Quickly press the "Volume (+)", followed by a long press of the "Volume (-)" until the number is dialed.
•Discreet mode:	Quickly press the "Volume (+)" button.
•Exit discreet mode:	During the call, quickly press the "Volume (+)" button followed by a press of the "Volume (-)" button
•Increase the volume:	During the call, press the "Volume (+)" button and then on the "Volume (-)" button repeat this procedure until you reach the required volume.
•Lower the volume:	During the call, press the "Volume (-)" button and then on the "Volume (+)" button repeat this procedure until you reach the required volume.

### The followings functions are only possible with Parrot CK3000 Evolution

•Enter the menu:	Press the following sequence twice: "SEEK up" button then the "SEEK down" button. These buttons are used to search for radio stations.
•Go forward through the menu:	Press the "Volume (+)" button and then the "Volume (-)" button, leaving one second between each press.
•Go backwards through the menu:	Press the "Volume (-)" button and then the "Volume (+)" button, leaving one second between each press.
•Select a menu option:	Press the "Volume (+)" button.
•Cancel a function:	Press the "Volume (-)" button.
•Reset the hands-free kit:	Repeat the following sequence five times: press the "Volume (-)" button and then the "Volume (+)" button.

# Wiring diagram for CK3000 EVOLUTION and CK3100 LCD

It is important to follow the wiring diagram for your vehicle. We would advise our customers to have the interface fitted by a professional.

In this technical document, you will find all information for correctly install your PARROT MULTICOMM interface.

**CK3000 EVOLUTION**

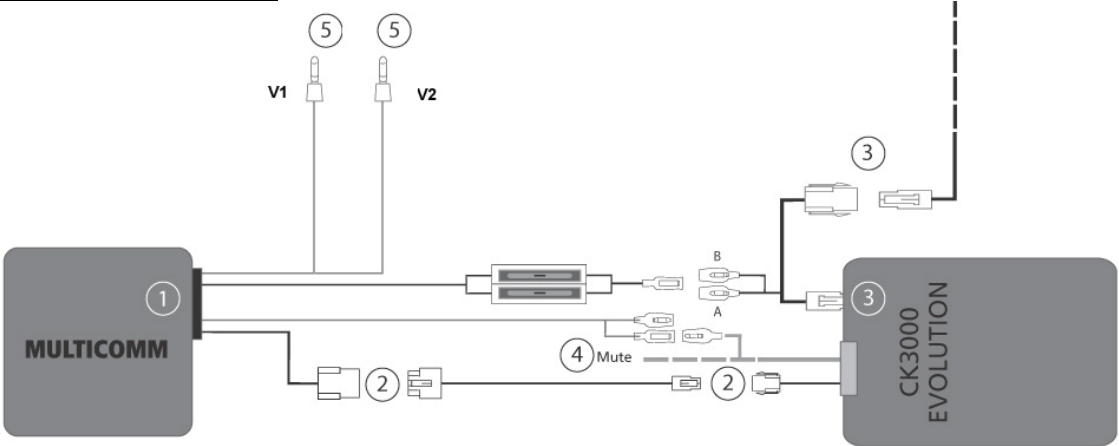

**CK3100 LCD**

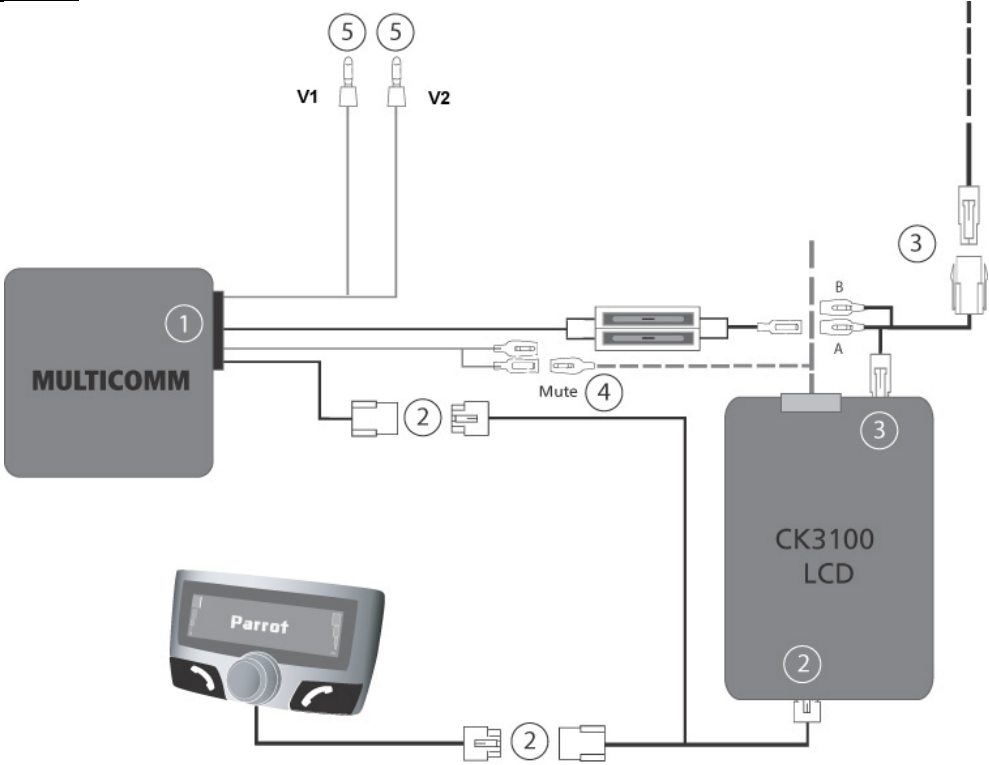

**1** **PARROT MULTICOMM interface**

The **Parrot MULTICOMM** is powered with 12Vdc having negative to the ground.  
 The **Parrot MULTICOMM** 14 ways connector has 5 wires that are important for the right working:

Connect the power cable of the **Parrot MULTICOMM** interface to the 14-way connector of the **Parrot MULTICOMM** interface.

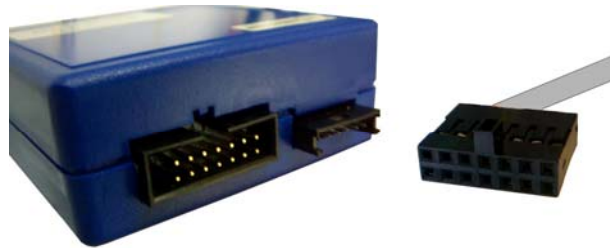

N°			Color	Function
1	Red	Orange	Red / Orange	12v Permanent
2	Yellow		Yellow	Mute input
3	Pink		Pink	
4	Green	Black	Green / Black	
5	Blue		Blue	
6	Yellow	White	Yellow / White	
8	Yellow	Brown	Yellow /Brown	
9	Grey		Grey	
10	White		White	V2
11	Blue	Red	Blue / Red	
12	Brown		Brown	
13	Purple		Purple	V1
14	Black		Black	Ground

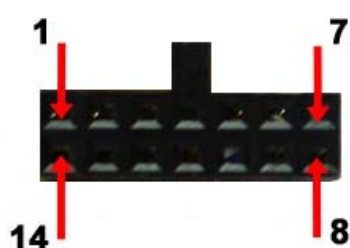

Front view

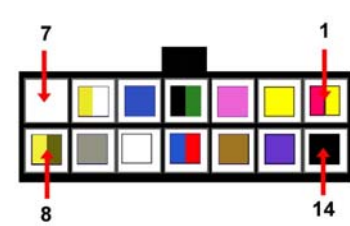









Back view

2



## Keypad Adapter

Join the connector of the kit's control keypad to the connector on the interface's power cable.

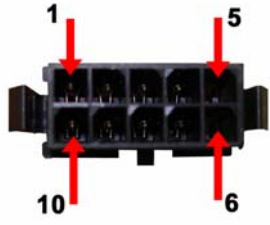
Pin Number		Colour
1		Yellow / Brown
2		Grey
3		Yellow / White
4		Pink
7		Brown
8		Blue / Red
9		Green / Black
10		Blue







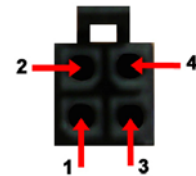



### In case of CK3000 EVOLUTION

Pin Number		Colour
2		Green
3		White / Yellow



### In case of CK3100 LCD

Pin Number		Colour
1		Black
2		Red / Blue
3		Green / Black
4		Brown
5		Green / Red
6		Grey / Black
7		Blue
8		Yellow / Red

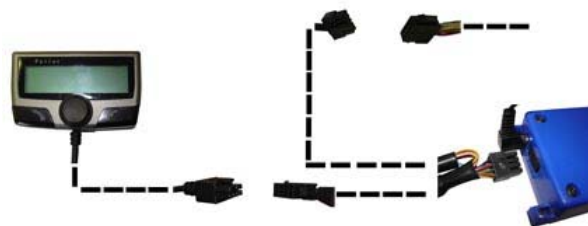
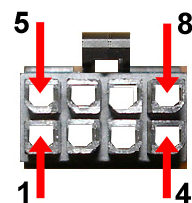

Connect the LCD display to the LCD adapter.

3

**Supply connections**

Pin Number	Colour	Description
1	Red	12v Permanent
2	Black	Ground
3	Orange	12v Ignition

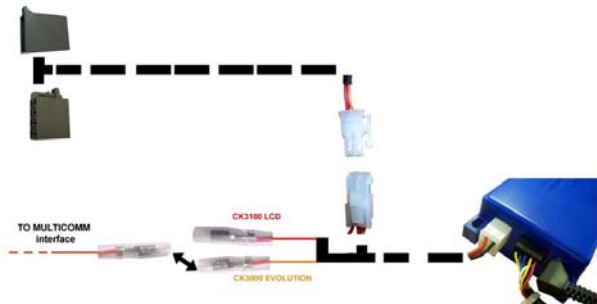
**CK3000 EVOLUTION**

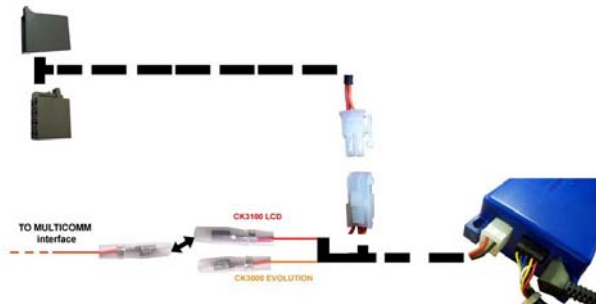

**CK3100 LCD**

Connect the Parrot MULTICOMM interface's power cable to the Parrot control unit and to the power cable of the hands-free kit.

4

**Mute input**

Colors	Cable	Description
Yellow	Mute cable	Mute Output
Yellow	MULTICOMM cable	Interface Mute input
White	ISO Power cable	Mute input 1
Yellow	ISO Power cable	Mute input 2
Blue	ISO Power cable	Mute input 3

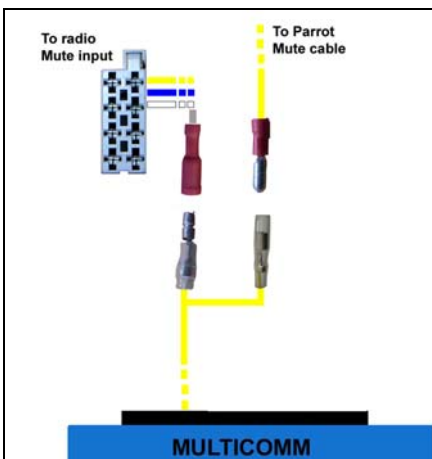

Connect the yellow mute wire of the Parrot MULTICOMM interface :

- To the Parrot yellow mute wire
- And to the car stereo's mute input if applicable

Notes:

If you don't know where your mute input is, see the usual guide of your radio or contact your Alfa Romeo dealer for having the correct position of mute input.

5

### Alfa Romeo protocol configuration

The wires corresponding to the Alfa Romeo protocol configuration must be connected correctly to your car stereo's information. It is important to follow the wiring diagram for your vehicle. We would advise our customers to have the interface fitted by a professional.

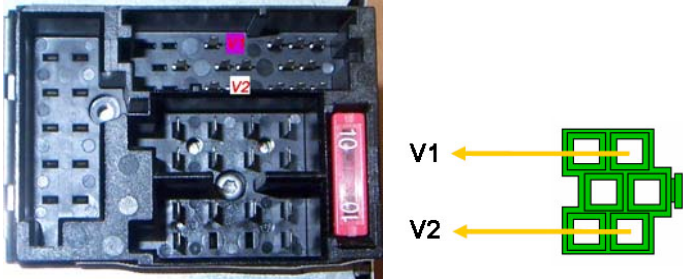
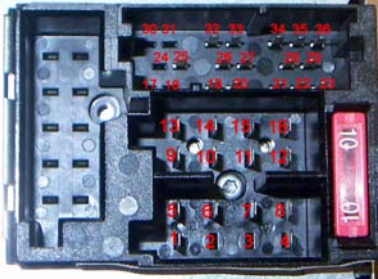
N°	Colour	Function	Connectors
33	Purple	V1	
20	White	V2	

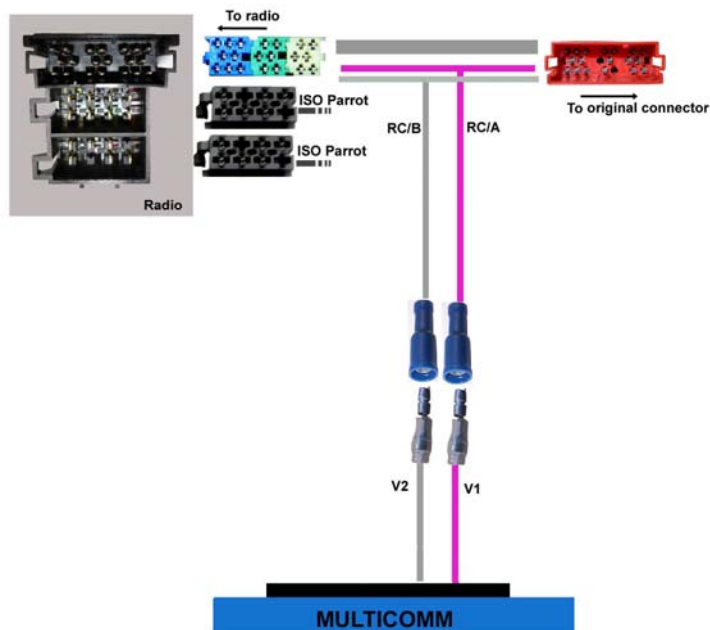

Connect the purple wire corresponding to V1 (RC/A) to pin 33.  
 Connect the white wire corresponding to V2 (RC/B) to pin 20.